

# Planning MATCH (1/2)

müller

**Note:** Back panels and boxes are fixed between 2 shelves. For stability reasons, a minimum of 4 shelves and 2 back panels or boxes must be planned for each unit.

Mark the back panels with "X" if the version with hole pattern is desired.

## Planning template

		15 cm	15 cm	15 cm	15 cm	15 cm	15 cm	15 cm	15 cm	15 cm	15 cm	15 cm	15 cm	15 cm	15 cm	15 cm	15 cm	15 cm	15 cm	15 cm	15 cm	15 cm	15 cm	15 cm
215 cm 179 cm	36 cm																							
	26 cm																							
	36 cm																							
	26 cm																							
	36 cm																							
	36 cm																							
	19 cm																							

### Colour(s)

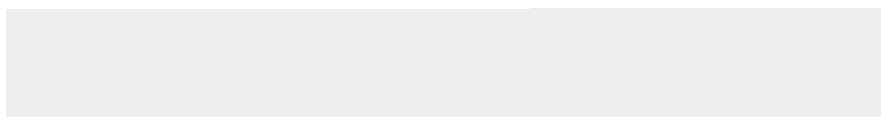

### Mirror

- small 35 × 70 cm
- large 40 × 100 cm

### Shelf



### Box (height = 34 cm) with hinged door

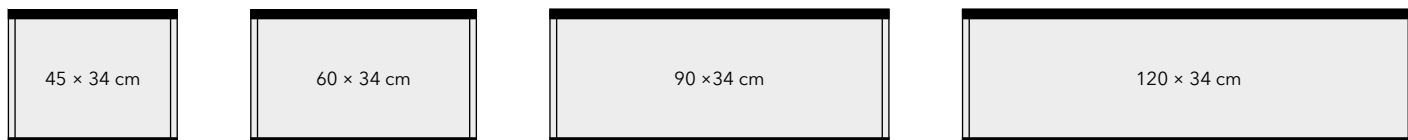

### Box (height = 34 cm) with 2 drawers

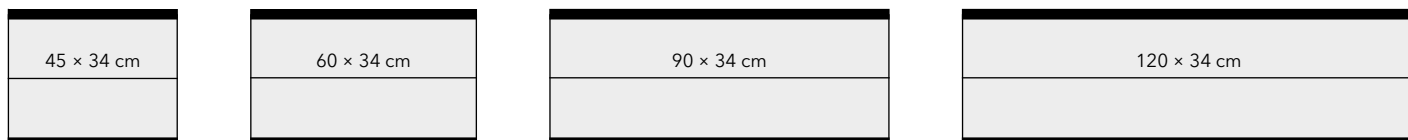

# Planning MATCH (2/2)

müller

**Note:** Back panels and boxes are fixed between 2 shelves. For stability reasons, a minimum of 4 shelves and 2 back panels or boxes must be planned for each unit.

Mark the back panels with "X" if the version with hole pattern is desired.

**Back panel (height = 24 cm) solid metal or with hole pattern**

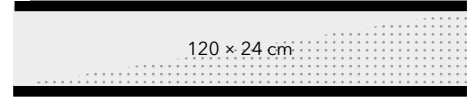
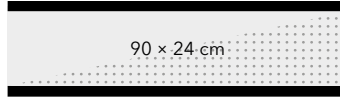
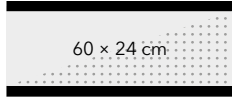
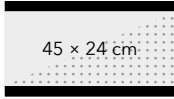

**Back panel (height = 34 cm) solid metal or with hole pattern**

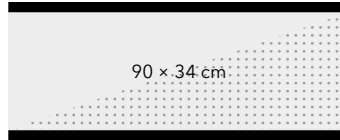
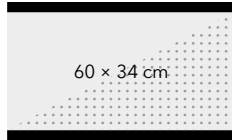
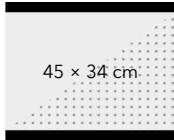

**Back panel (height = 60 cm) hole pattern | option: solid metal for width = 45 cm**

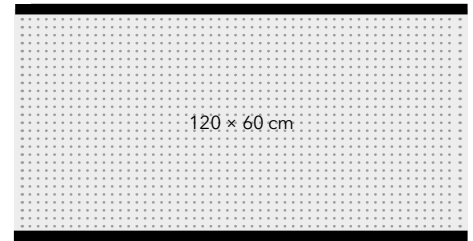
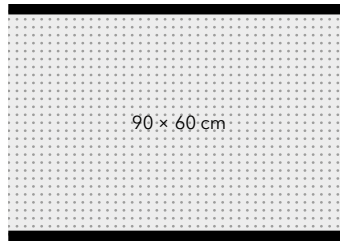
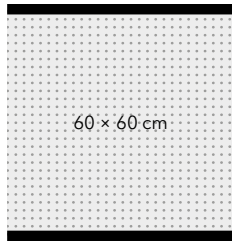

**Back panel (height = 86 cm) with hole pattern | option: mirror small 35 × 70 cm**

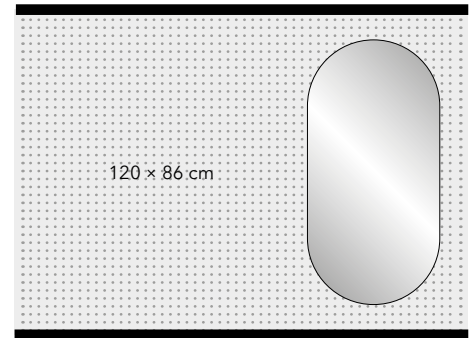
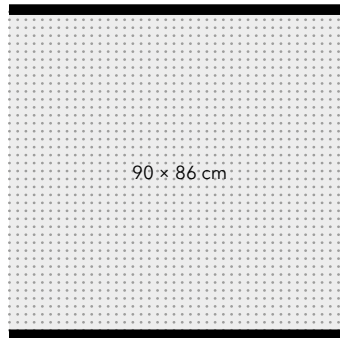
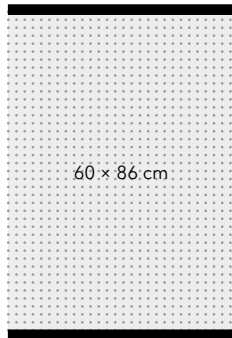
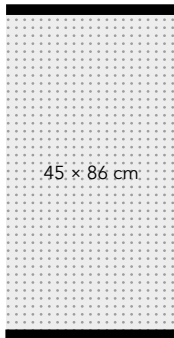

**Back panel (height = 122 cm) with hole pattern | option: mirror small 35 × 70 cm or large 40 × 100 cm**

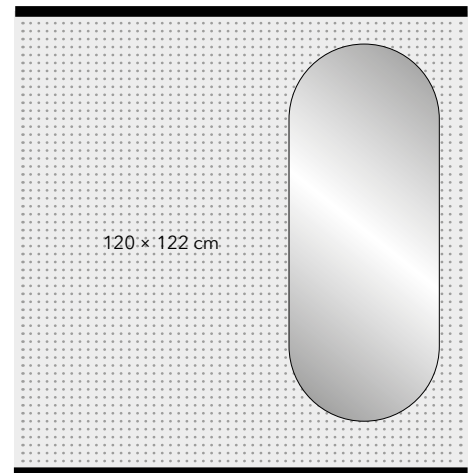
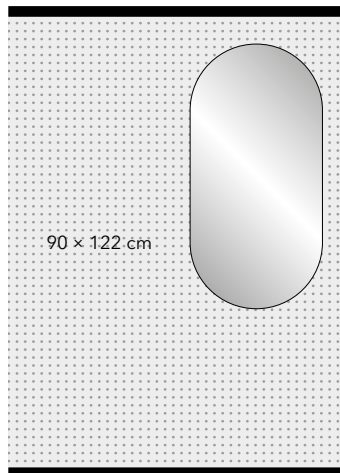
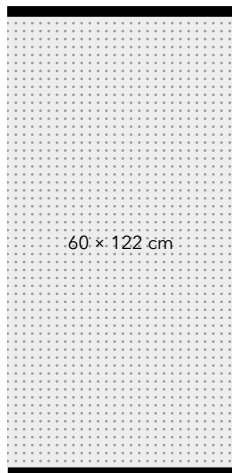

# Example: Planning MATCH

**Note:** Back panels and boxes are fixed between 2 shelves. For stability reasons, a minimum of 4 shelves and 2 back panels or boxes must be planned for each unit.  
Mark the back panels with "X" if the version with hole pattern is desired.

## Planning template

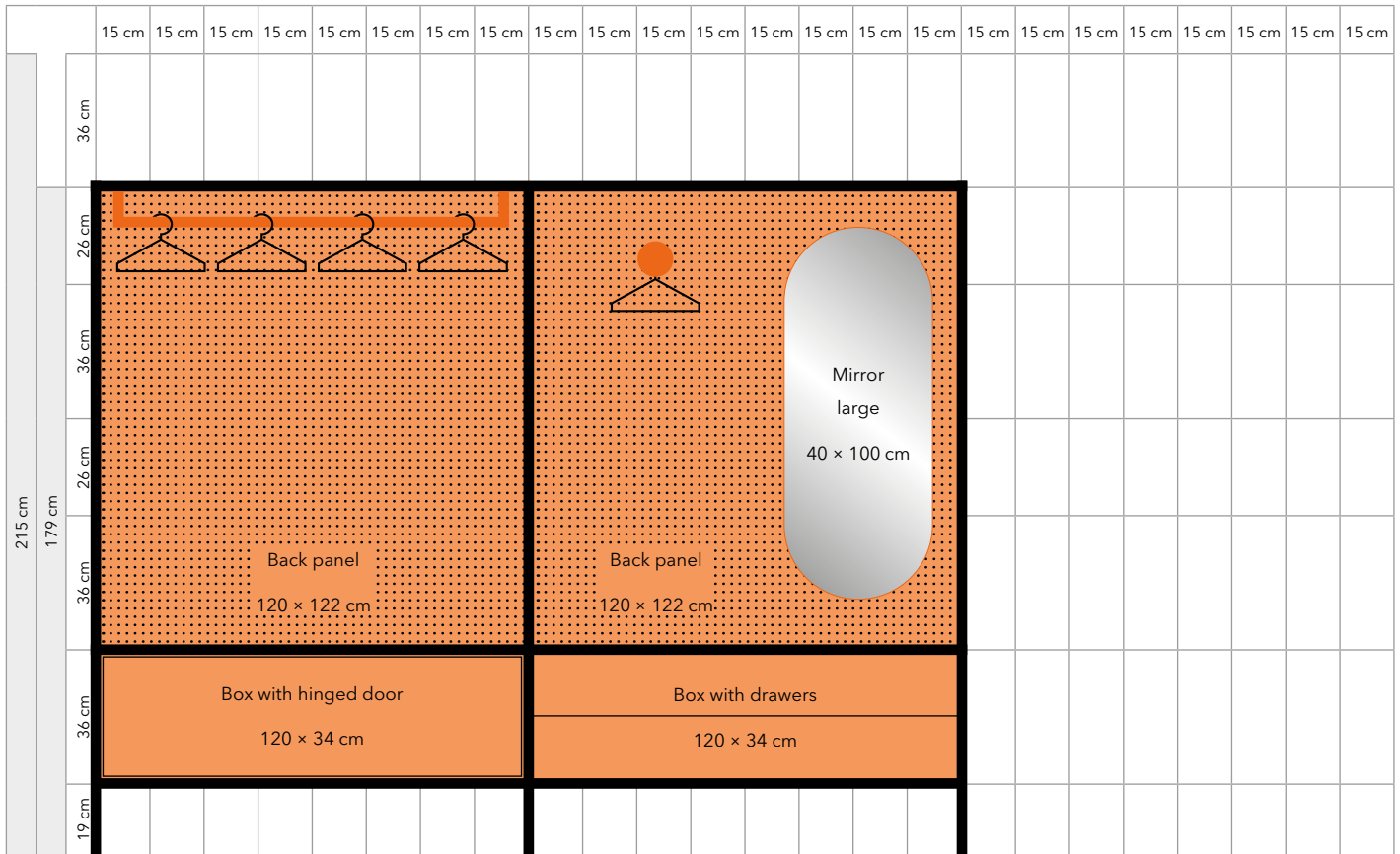

### Colour(s)

RAL 2008 Bright red orange

### Mirror

small 35 x 70 cm

X large 40 x 100 cm

### Shelf



### Box (height = 34 cm) with hinged door



### Box (height = 34 cm) with 2 drawers

